

# Block mounting filter, lateral flange-mounting possible

**RE 51405/12.10**  
Replaces: 02.09

1/16

**Types 250/450 FEN 0040 to 1000; 250/450 FE 0003, 0015, 0018**

Nominal sizes **according to DIN 24550**: 0040 to 1000  
 Nominal sizes according to BRFS: 0003, 0015, 0018  
 Nominal pressures 250, 450 bar  
 Connections up to SAE 2 1/2"  
 Operating temperature -10 °C to +100 °C

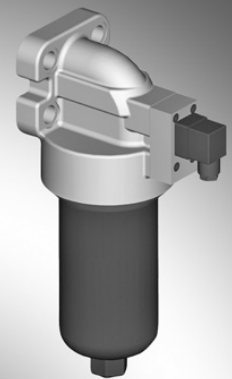

41\_02\_d.eps

## Table of contents

Contents	Page
Application, features	1
Design, filter element, accessories, quality and standardization	2
Ordering details	3
Preferred types	4, 5
Ordering details:	
Electronic switching element for clogging indicator	6
Plug-in connectors	6
Symbols	7
Technical data	8
Characteristic curves	9 ... 12
Unit dimensions	13
Spart parts	14, 15
Installation, commissioning, maintenance	16

## Application

- Filtration of pressure fluids and lubricants.
- Filtration of fluids and gases.
- Direct installation into pipelines.
- Direct wear protection of downstream components and systems.

## Features

- Flow-optimized design due to 3D computer-supported design.
- Low pressure drop.
- Special highly efficient filter media

## Design

---

Filter head with inlet, outlet and filter element centering spigot. Filter bowl is unscrewed downwards.

Materials: See spare parts list in this brochure.

Further design variants available on request.

## Filter element

---

Pleated design with optimized pleat density and various filter media.

The filter element is the most important component of the "FILTER" system in view of the prolonged life and the wear protection of the systems.

The most important criteria for selection are the required degree of cleanliness of the operating medium, the initial pressure differential and the contamination retention capacity.

For further detailed information please refer to our brochure "Filter Elements".

## Accessories

---

### Clogging indicator

Basically, the filter is equipped with mechanical optical clogging indicator. The electronic clogging indicator is connected via the electronic switching element with 1 or 2 switching points, which has to be ordered separately. The electronic switching element is attached to the mechanical optical clogging indicator and held by means of a locking ring.

## Characteristic curves

---

An optimum filter selection is made possible by our "BRFilterSelect" software, see download area <http://www.eppensteiner.de>.

Additional characteristic curves for the filters in this catalogue can be found in the BRFS filter calculation program.

## Quality and standardization

---

The development, manufacture, and assembly of BRFS industrial filters and BRFS filter elements is carried out within the framework of a certified quality management system in accordance with ISO 9001:2000.

The pressure filters for hydraulic applications according to 51405 are pressure holding equipment according to article 1, section 2.1.4 of the pressure equipment directive 97/23/EC (DGRL). However, on the basis of the exception in article 1, section 3.6 of the DGRL, hydraulic filters are exempt from the DGRL if they are not classified higher than category I (guideline 1/19). They do not receive a CE mark.



## Preferred types

### Line filter with lateral flange-mounting possibility, without bypass, filtration rating 10 µm and nominal pressure 250 bar

Type	Flow in L/min at $v = 30 \text{ mm}^2/\text{s}$ and $\Delta p = 1 \text{ bar}$	Material number
250 FE 0003 H10XL-B00-00V5,0-00M00	43	R928001090
250 FEN 0040 H10XL-B00-00V5,0-00M00	49	R928001084
250 FEN 0063 H10XL-B00-00V5,0-00M00	70	R928001085
250 FEN 0100 H10XL-B00-00V5,0-00M00	90	R928001086
250 FE 0015 H10XL-B00-00V5,0-00M00	153	R928001091
250 FE 0018 H10XL-B00-00V5,0-00M00	175	R928001092
250 FEN 0160 H10XL-B00-00V5,0-00M00	215	R928001087
250 FEN 0250 H10XL-B00-00V5,0-00M00	258	R928001088
250 FEN 0400 H10XL-B00-00V5,0-00M00	330	R928001089

### Line filter with lateral flange-mounting possibility, without bypass, filtration rating 3 µm and nominal pressure 250 bar

Type	Flow in L/min at $v = 30 \text{ mm}^2/\text{s}$ and $\Delta p = 1 \text{ bar}$	Material number
250 FE 0003 H3XL-B00-00V5,0-00M00	18	R928001081
250 FEN 0040 H3XL-B00-00V5,0-00M00	21	R928001075
250 FEN 0063 H3XL-B00-00V5,0-00M00	33	R928001076
250 FEN 0100 H3XL-B00-00V5,0-00M00	50	R928001077
250 FE 0015 H3XL-B00-00V5,0-00M00	74	R928001082
250 FE 0018 H3XL-B00-00V5,0-00M00	95	R928001083
250 FEN 0160 H3XL-B00-00V5,0-00M00	115	R928001078
250 FEN 0250 H3XL-B00-00V5,0-00M00	160	R928001079
250 FEN 0400 H3XL-B00-00V5,0-00M00	230	R928001080

### Line filter with lateral flange-mounting possibility, without bypass, filtration rating 10 µm and nominal pressure 450 bar

Type	Flow in L/min at $v = 30 \text{ mm}^2/\text{s}$ and $\Delta p = 1 \text{ bar}$	Material number
450 FE 0003 H10XL-B00-00V5,0-00M00	43	R928001148
450 FEN 0040 H10XL-B00-00V5,0-00M00	49	R928001140
450 FEN 0063 H10XL-B00-00V5,0-00M00	70	R928001141
450 FEN 0100 H10XL-B00-00V5,0-00M00	90	R928001142
450 FE 0015 H10XL-B00-00V5,0-00M00	153	R928001149
450 FE 0018 H10XL-B00-00V5,0-00M00	175	R928001150
450 FEN 0160 H10XL-B00-00V5,0-00M00	215	R928001143
450 FEN 0250 H10XL-B00-00V5,0-00M00	258	R928001144
450 FEN 0400 H10XL-B00-00V5,0-00M00	330	R928001145
450 FEN 0630 H10XL-B00-00V5,0-00M00	495	R928001146
450 FEN 1000 H10XL-B00-00V5,0-00M00	610	R928001147

## Preferred types

Line filter with lateral flange-mounting possibility, without bypass, filtration rating 3  $\mu\text{m}$  and nominal pressure 450 bar

Type	Flow in L/min at $v = 30 \text{ mm}^2/\text{s}$ and $\Delta p = 1 \text{ bar}$	Material number
450 FE 0003 H3XL-B00-00V5,0-00M00	18	R928001137
450 FEN 0040 H3XL-B00-00V5,0-00M00	21	R928001129
450 FEN 0063 H3XL-B00-00V5,0-00M00	33	R928001130
450 FEN 0100 H3XL-B00-00V5,0-00M00	50	R928001131
450 FE 0015 H3XL-B00-00V5,0-00M00	74	R928001138
450 FE 0018 H3XL-B00-00V5,0-00M00	95	R928001139
450 FEN 0160 H3XL-B00-00V5,0-00M00	115	R928001132
450 FEN 0250 H3XL-B00-00V5,0-00M00	160	R928001133
450 FEN 0400 H3XL-B00-00V5,0-00M00	230	R928001134
450 FEN 0630 H3XL-B00-00V5,0-00M00	290	R928001135
450 FEN 1000 H3XL-B00-00V5,0-00M00	400	R928001136

## Ordering details: electronic switching element for clogging indicator

**ABZ F V - -1X/-DIN**

Rexroth power unit accessories

Filter

Clogging indicator

electronic switching element with 1 switching point (changeover)  
round plug-in connection M12x1 = **E1SP-M12X1**

electronic switching element with 2 switching points (normally open/normally closed), 75%, 100%, round plug-in connection M12x1, 3 LED = **E2SP-M12X1**

electronic switching element with 2 switching points (normally open/normally closed), 75%, 100%, signal suppression until 30 °C  
round plug-in connection M12x1, 3 LED = **E2SPSU-M12X1**

-DIN =

Identification for  
DIN and SAE models

1X =

**Unit series**  
unit series 10 to 19  
(10 to 19; unchanged installation  
and connection dimensions)

Electronic switching element	Material no.
ABZFV-E1SP-M12X1-1X/-DIN	R901025339
ABZFV-E2SP-M12X1-1X/-DIN	R901025340
ABZFV-E2SPSU-M12X1-1X/-DIN	R901025341

**Ordering example:** Pressure filter with mechanical optical clogging indicator for  $p_{nom.} = 450 \text{ bar}$  [6530 psi] with bypass valve, nominal size 63, with filter element 10 µm and electronic switching element M12x1 with 1 switching point for pressure liquid mineral oil HLP according to DIN 51524.

**Filter:** 450 FEN 0063 H10XL-B00-00V5,0-00M00 **Material number: R928001141**

**Clogging indicator:** ABZFV-E1SP-M12X1-1X/-DIN **Material number: R901025339**

## Plug-in connectors according to IEC 60947-5-2 (dimensions in mm [inch])

for electronic switching element with round plug-in connection M12 x 1

Plug-in connector for K24 4-pin, M12 x 1  
with screwed connection, cable fitting Pg9.

Material no. R900031155

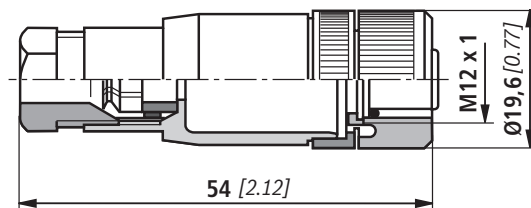

Plug-in connector for K24-3m 4-pin, M12 x 1  
with molded in PVC cable, 3 m long.

Line cross-section: 4 x 0.34 mm<sup>2</sup>

Core marking:

- 1 brown
- 2 white
- 3 blue
- 4 black

Material no. R900064381

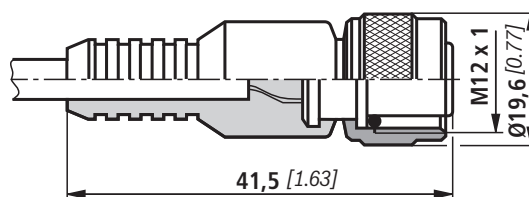

For additional round plug-in connections, see data sheet 08006.

# Symbols

Pressure filter  
without bypass, with  
mechanical display

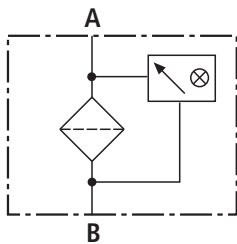

Electronic switching element for  
clogging indicator

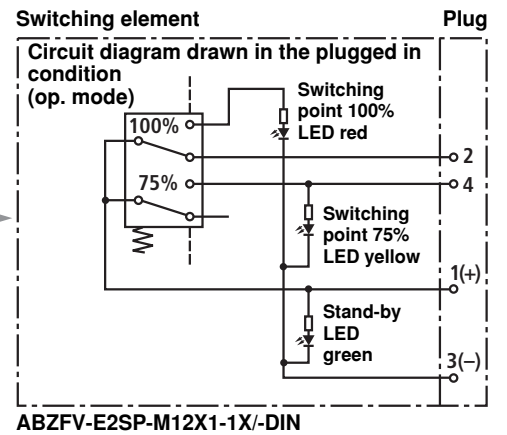
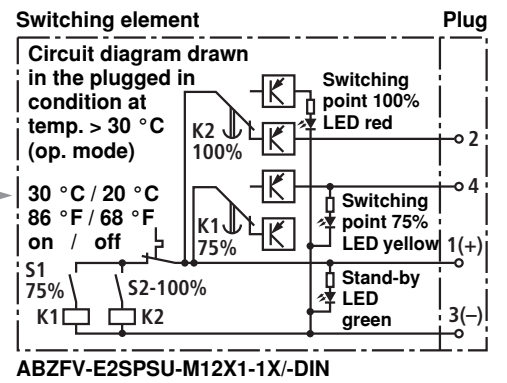
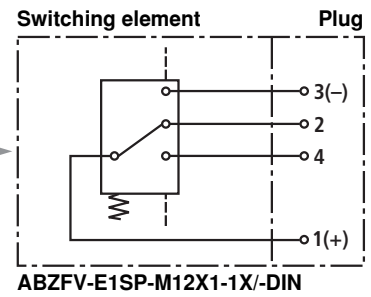

**Technical data** (for applications outside these parameters, please consult us!)**Electronic** (electric switching element)

Electrical connection		Round plug-in connection M12 x 1, 4-pin
Contact load, direct voltage	A	Max. 1
Voltage range	E1SP-M12x1 V DC/AC	Max. 150
	E2SP V DC	10 to 30
Max. switching capacity with ohmic loads		20 VA; 20 W; (70 VA)
Switching type	E1SP-M12x1	Changeover
	E2SP-M12x1	Normally open at 75% of the response pressure, Normally closed at 100% of the response pressure
	E2SPSU-M12x1	Normally open at 75% of the response pressure, Normally closed at 100% of the response pressure Signal switching through at 30 °C [86 °F], Return switching at 20 °C [68 °F]
Display via LEDs in the electronic switching element E2SP...		Stand-by (LED green); 75% switching point (LED yellow) 100% switching point (LED red)
Type of protection according to EN 60529		IP 65
For direct voltage above 24 V a spark suppression is to be provided to protect the switching contacts.		
Weight electronic switching element: – with round plug-in connection M12 x 1	kg [lbs]	0.1 [0.22]



## Characteristic curves

H3XL...

Specific weight: <math>< 0.9 \text{ kg/dm}^3</math>

$\Delta p$ -Q characteristic curves for complete filters recommended  
initial  $\Delta p$  for design = 1 bar

An optimum filter selection is made possible by our computer program "BRFilterSelect".

Oil viscosity:  
 ——— 120 mm<sup>2</sup>/s  
 - · - · 46 mm<sup>2</sup>/s  
 - - - 30 mm<sup>2</sup>/s

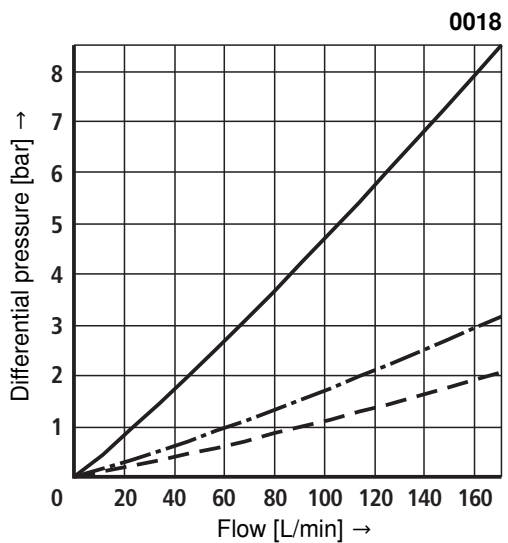
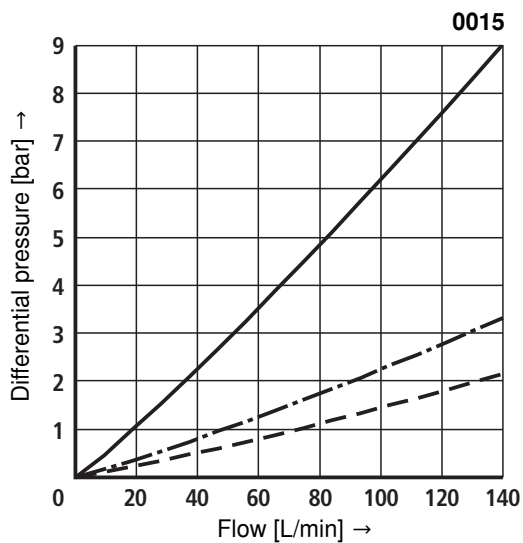
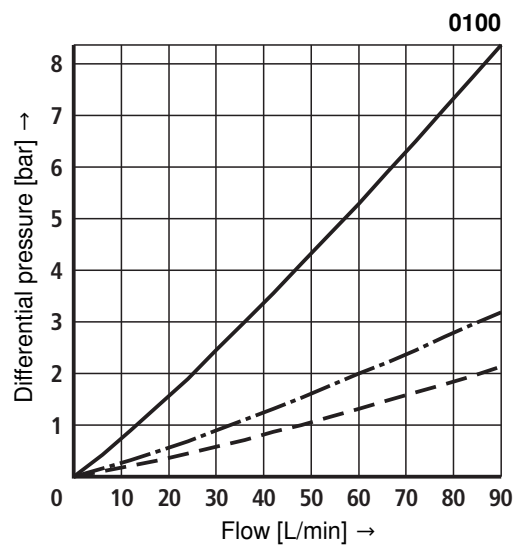
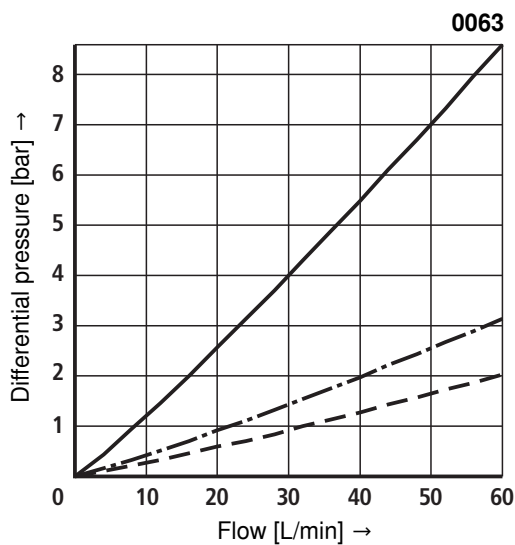
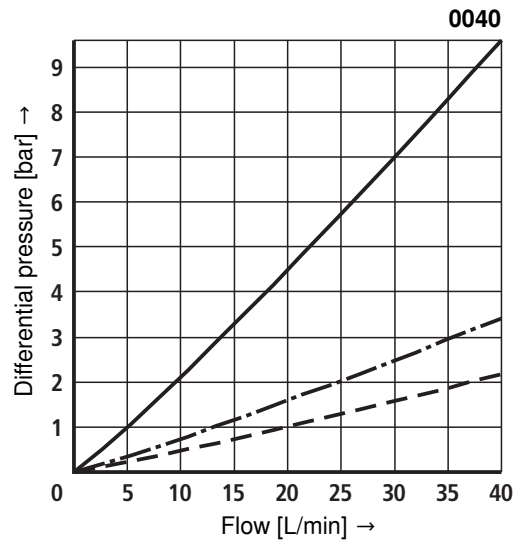
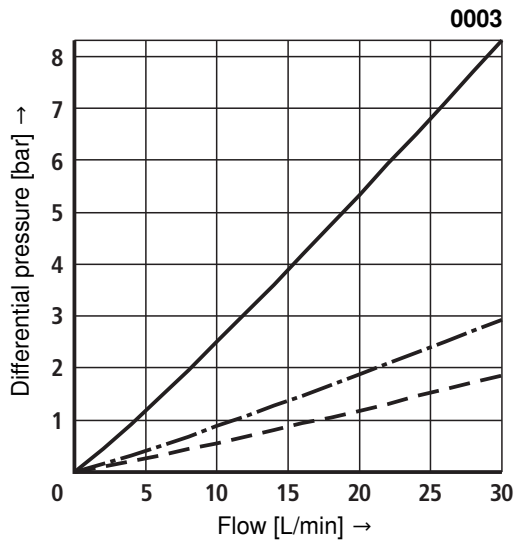

### Characteristic curves

H3XL...

Specific weight: <math>< 0.9 \text{ kg/dm}^3</math>  
 $\Delta p$ -Q characteristic curves for complete filters recommended  
 initial  $\Delta p$  for design = 1 bar

An optimum filter selection is made possible by our computer  
 program "BRFilterSelect".

Oil viscosity:  
 ——— 120 mm<sup>2</sup>/s  
 - · - · 46 mm<sup>2</sup>/s  
 - - - 30 mm<sup>2</sup>/s

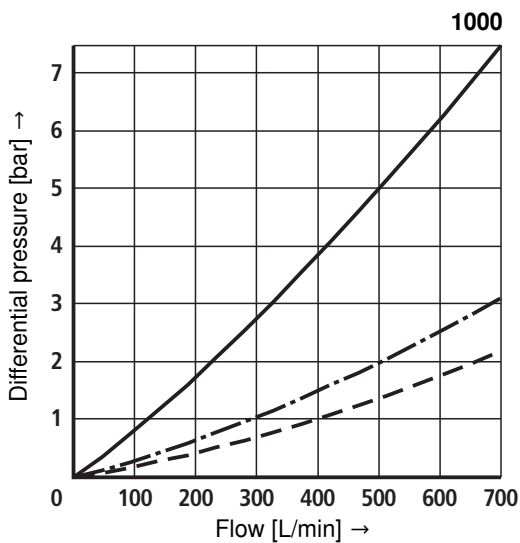
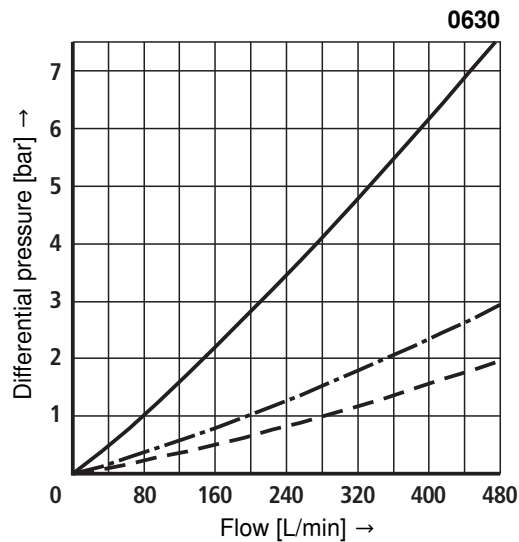
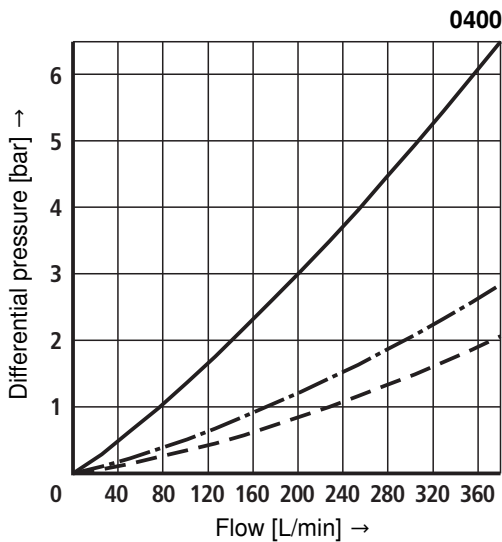
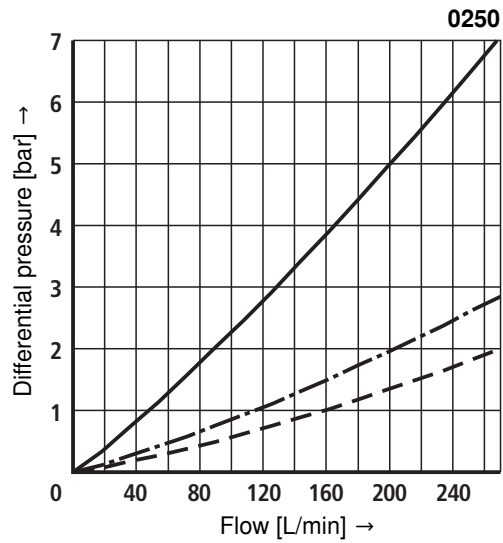
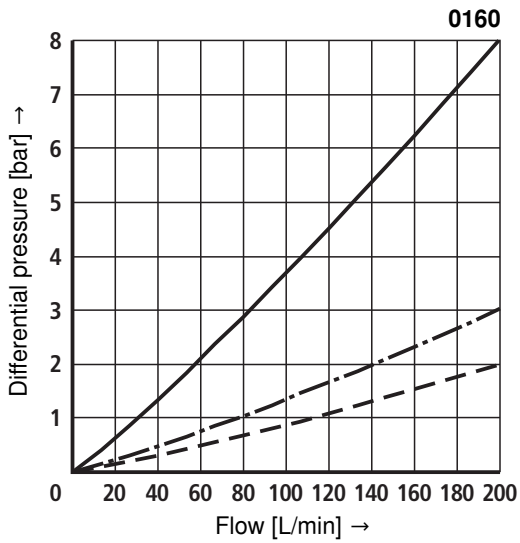

## Characteristic curves

## H10XL...

Specific weight:  $< 0.9 \text{ kg/dm}^3$

$\Delta p$ -Q characteristic curves for complete filters recommended  
initial  $\Delta p$  for design = 1 bar

An optimum filter selection is made possible by our computer program "BRFilterSelect".

Oil viscosity:  
 — 120 mm<sup>2</sup>/s  
 - · - 46 mm<sup>2</sup>/s  
 - - - 30 mm<sup>2</sup>/s

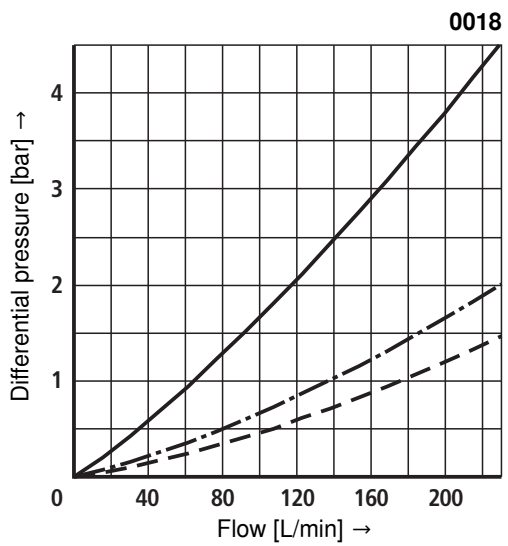
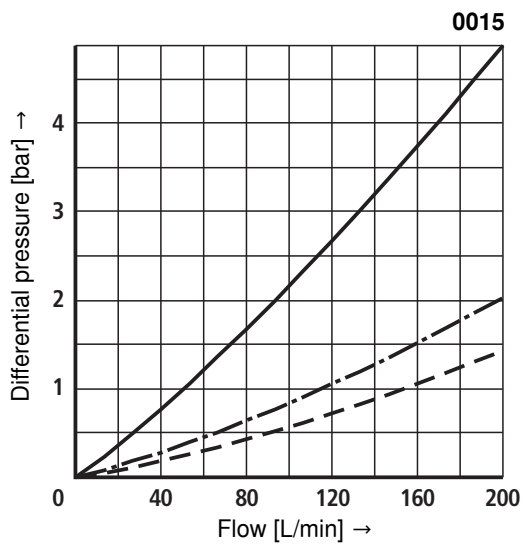
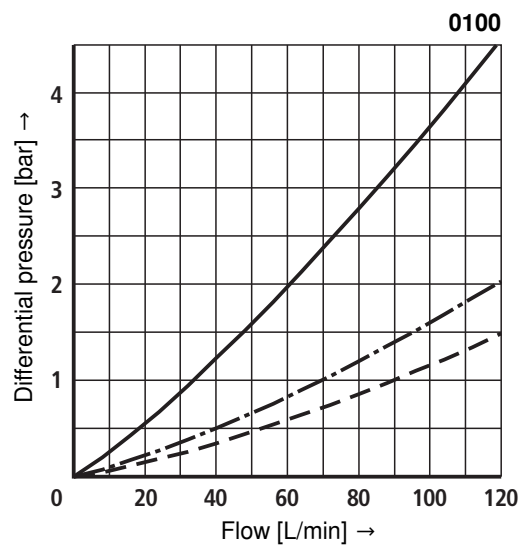
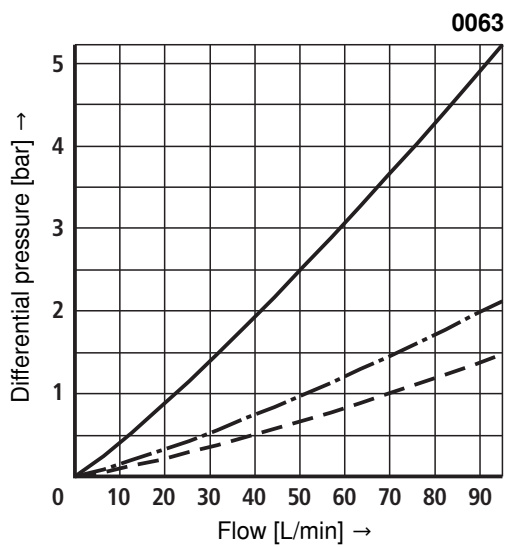
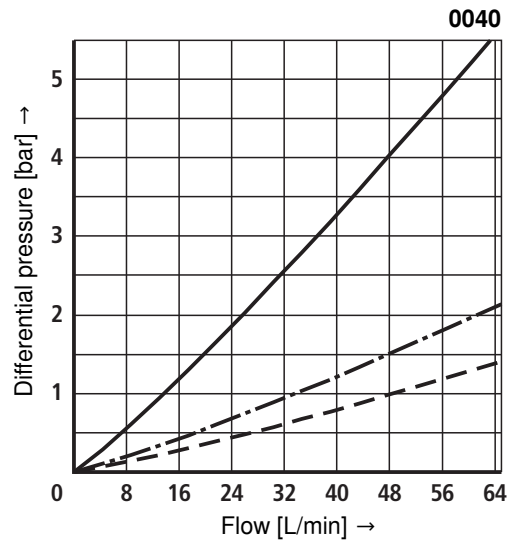
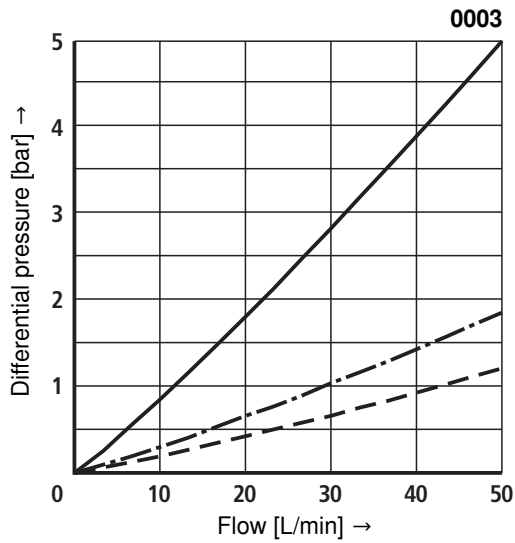

### Characteristic curves

### H10XL...

Specific weight: < 0.9 kg/dm<sup>3</sup>  
 Δp-Q characteristic curves for complete filters recommended  
 initial Δp for design = 1 bar

An optimum filter selection is made possible by our computer  
 program "BRFilterSelect".

Oil viscosity:   
 ——— 120 mm<sup>2</sup>/s  
 - · - · 46 mm<sup>2</sup>/s  
 - - - 30 mm<sup>2</sup>/s

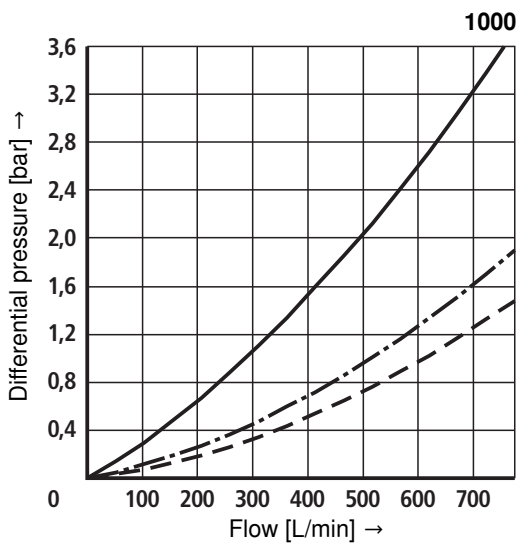
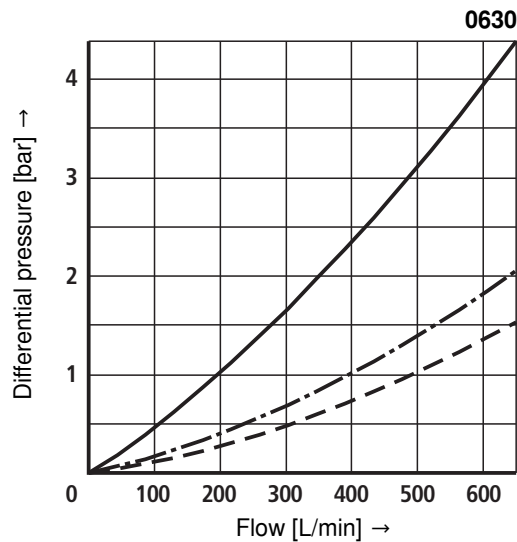
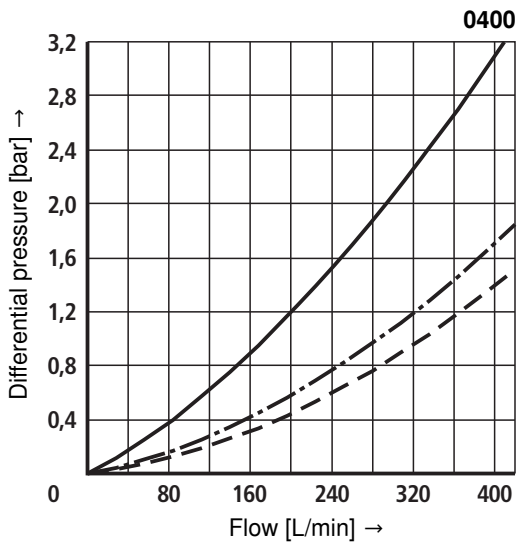
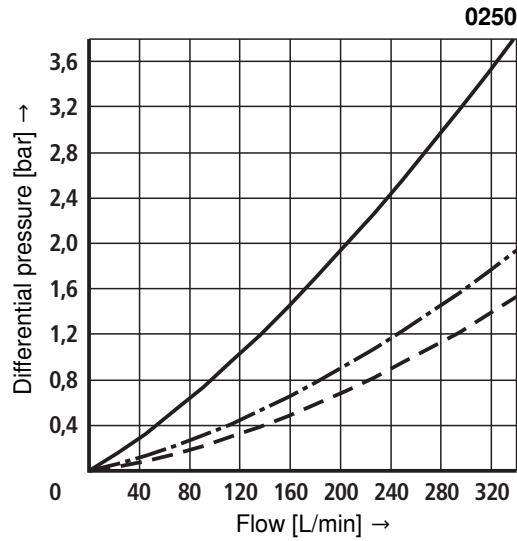
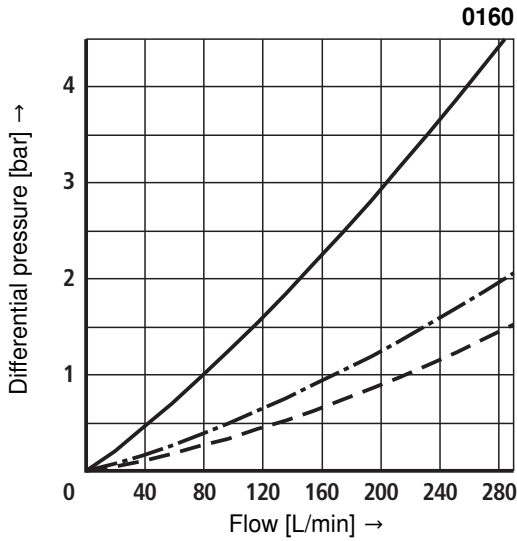

## Unit dimensions (dimensions in mm)

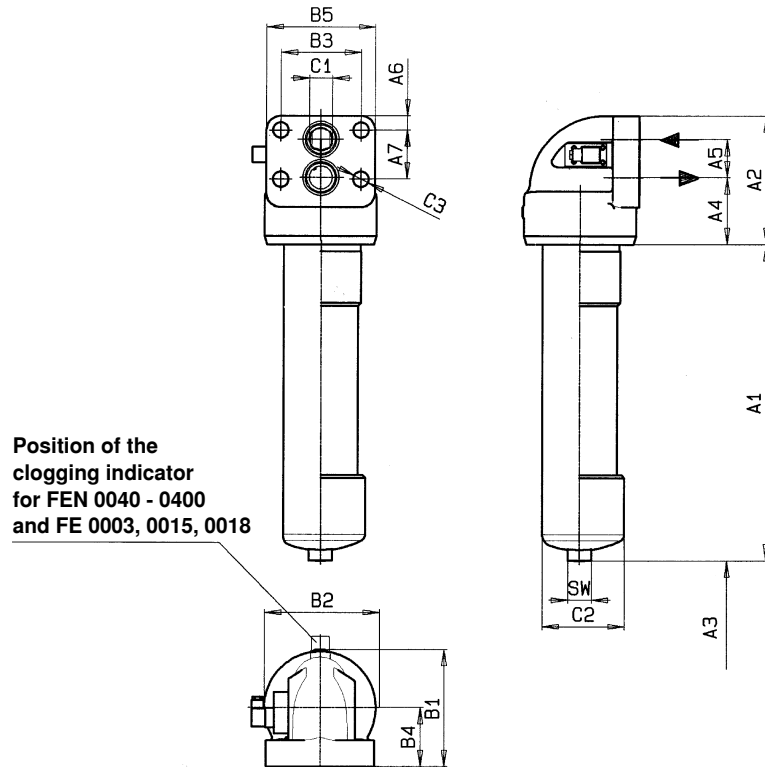

### Filter housing for filter elements in accordance with DIN 24550

Type	Content in L	Weight in kg <sup>1)</sup>	A1	A2	A3 <sup>2)</sup>	A4	A5	A6	A7	B1	B2	B3	B4	B5	C1	C2	C3	SW
250/450 FEN 0040	0.2	4.6	98															
250/450 FEN 0063	0.3	5.9	161	112	110	56	28	12	45	95	88	57	48	80	Ø 14	Ø 64	Ø 14	24
250/450 FEN 0100	0.5	6.1	251															
250/450 FEN 0160	1.3	16.5	167															
250/450 FEN 0250	1.9	19.2	257	160		79.5	52	22.5	60	156	150	95	80	140	Ø 32	Ø 114	Ø 23	32
250/450 FEN 0400	3.0	24.1	407		150													
450 FEN 0630	4.5	47.5	421			117	67	25	86	199	195	140	99	190	Ø 50	Ø 140	Ø 27	41
450 FEN 1000	6.2	67.5	641	225											Ø 160			

### Filter housing for filter elements according to BRFS standard

Type 250/450 FE...	Content in L	Weight in kg <sup>1)</sup>	A1	A2	A3 <sup>2)</sup>	A4	A5	A6	A7	B1	B2	B3	B4	B5	C1	C2	C3	SW
0003	0.2	4.6	98	112	100	56	28	12	45	95	88	57	48	80	Ø 14	Ø 64	Ø 14	24
0015	0.9	11.0	188	150	130	80	35	20	55	130	125	72	65	110	Ø 18	Ø 92	Ø 18	32
0018	1.1	12.7	239															

<sup>1)</sup> Weight including standard filter element and clogging indicator.

<sup>2)</sup> Withdrawal dimension for filter element replacement.

### Spare parts list

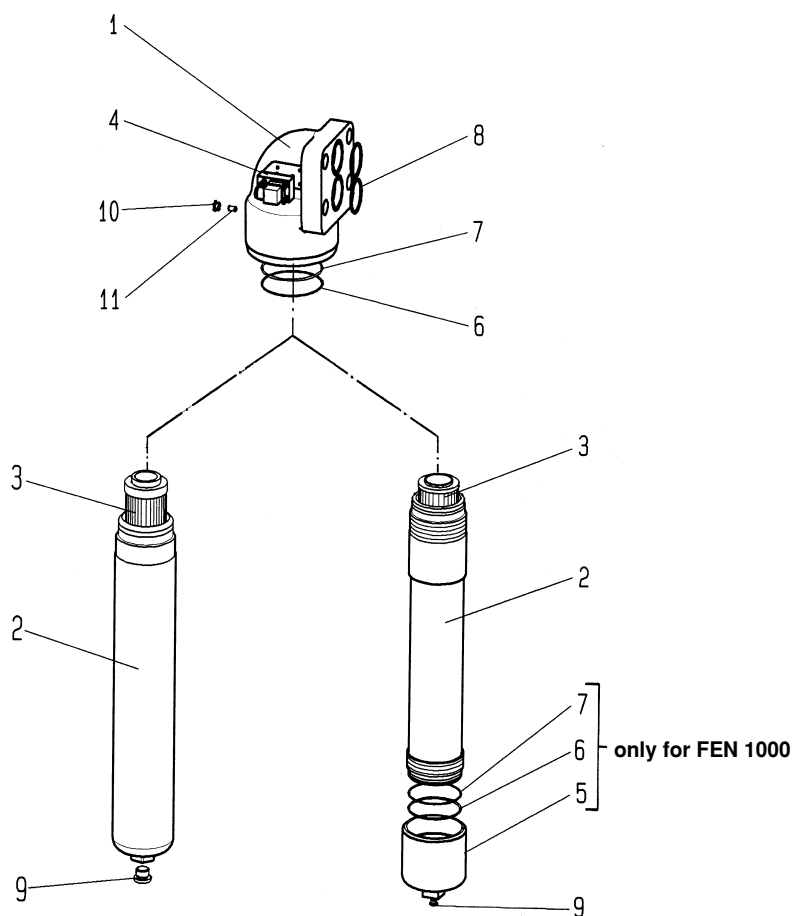

		Size FEN		0040	0063	0100			0160	0250	0400	0630	1000
		Size FE		0003			0015	0018					
Part	Piece	Description	Material										
1	1	Filter head	GGG50	Please indicate ordering information "Filter"									
2	1	Filter bowl	Steel	Please indicate ordering information "Filter"									
3	1	Filter element	various	Please indicate ordering information "Filter Element"									
3.1	1	Seal ring	NBR / FKM	Please indicate ordering information "Filter"									
4	1	Clogging indicator	various	See ordering information "Clogging indicator"									
5	1	Bottom	Steel	-									Part No. 4374
6	2	Support ring	PTFE	Please indicate ordering information "Filter"									
7	2	Seal ring	NBR / FKM	Please indicate ordering information "Filter"									
8	2	Seal ring	NBR / FKM	Please indicate ordering information "Filter"									
9	1	Plug	Steel	Part No. 778									
10	1	Plug	Steel	-									Part No. 771
11	1	Set screw with hexagon socket	5.8	-									Part No. 4371

All part numbers BRFS specific.

## Spare parts (insert for DIN and SAE filters)

### Mechanical optical clogging indicator

Rexroth power unit accessories

Filter

Clogging indicator

Mechanical optical clogging indicator for high-pressure filters

Switching point 5 bar [72 psi]

ABZ	F	V	HV5	1X	/	DIN
-----	---	---	-----	----	---	-----

= HV5

1X =

DIN =

Identification for DIN and SAE models

#### Sealing material

see table below

see table below

#### Unit series

unit series 10 to 19

(10 to 19; unchanged installation and connection dimensions)

Mechanical optical clogging indicator	Material no.
ABZ FV-HV5-1X/M-DIN	R901025313

The ordering details for filter elements can be found on page 3.

**Sealing kits must be ordered by stating the complete part key.**

## Sealing material and surface coating for pressure fluids

		Ordering details	
		Sealing material	Element model
<b>Mineral oils</b>			
Mineral oil	HLP according to DIN 51524	M	...0
<b>Fire-resistant hydraulic fluids</b>			
Emulsions	HFA-E according to DIN 24320	M	...0
Synthetic water solutions	HFA-S according to DIN 24320	M	...D
Water solutions	HFC according to VDMA 24317	M	...D
Phosphate esters	HFD-R according to VDMA 24317	V	...D
Organic esters	HFD-U according to VDMA 24317	V	...D
<b>Hydraulic fluids that are fast biodegradable</b>			
Triglycerides (rape seed oil)	HETG according to VDMA 24568	M	...D
Synthetic esters	HEES according to VDMA 24568	V	...D
Polyglycoles	HEPG according to VDMA 24568	V	...D

## Installation, commissioning and maintenance

---

### Installation

Verify operating pressure with name plate information.

Remove the plugs from the filter inlet and outlets. Fit the filter into the pipe work, ensuring that it is fitted free of tension and considering the flow direction (direction arrows) and the withdrawal height of the filter element (pos.3).

#### Warning!

Assemble and disassemble the filter only when system is depressurized!

Vessel is under pressure!

When disassembling the filter, please note that the filter inlet and the filter outlet need to be emptied separately!

Remove the filter bowl only if it is not pressurized!

Do not replace the clogging indicator while the filter is under pressure!

Functional and safety warranty only applicable when using genuine Rexroth spare parts!

Service filter only by trained personnel!

### Commissioning

Switch on system pump.

### Maintenance

If at operating temperature, the red indicator pin shows out of the clogging indicator (pos. 4) so far that it contacts the plastic cap and/or if the switching process in the electric display is triggered, the filter element is clogged and needs to be replaced or cleaned respectively.

### Filter element replacement

Switch off the system pump and depressurize the system.

Unscrew the filter bowl (pos. 2) and/or the bottom (pos. 5) (only with FEN 1000) of the filter bowl (pos. 2) and remove the filter element (pos. 3) from the centering spigot on the filter head (pos. 1) by turning it lightly.

Check the filter head for cleanliness and clean if necessary.

Replace filter elements H...-XL and P..., clean the filter element with material G ... .

The efficiency of the cleaning process depends on the type of contamination and the value of the pressure differential before the filter element was exchanged. If the pressure differential after replacing the filter element is more than 50% of the value before replacing the filter element then the G.... element also needs to be replaced.

Install the cleaned or new filter element with light turning movements back on to the centering spigot.

Check the seal ring (pos. 7) in the filter bowl for damage or wear and replace if necessary.

Screw on the filter bowl (pos. 2) and tighten via the hexagon using a suitable tool.

Carry out commissioning as described above.

Technical modifications reserved!